

Cable Rack Displays

These displays were designed with the dealer in mind. Now, cables can easily be displayed without taking up valuable shelf space. Simply hang them off the wall. We have redesigned our headercards so they hold the cable end preventing cables from falling out of their display bags. Dealers can easily stock more applications by stocking Motion Pro cables than if you stocked only OEM cables. Hang these below one of our Motion Pro Banners and let your customers see your commitment to quality products.

18" Cable Rack Display

121-01152

- Hold up to 200 cables on wall space of 18" x 11"
- Black epoxy finish
- Kit contains 2 racks, end pieces, hardware and display header

36" Cable Rack Display

121-01153

- Hold up to 500 cables on wall space of 36" x 17", with 14" depth
- White epoxy finish
- Kit contains 3 – 20-slot 36" cable racks, middle and end braces, hardware and display header cards

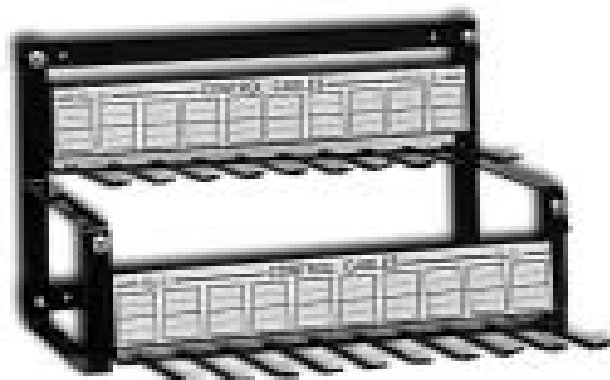
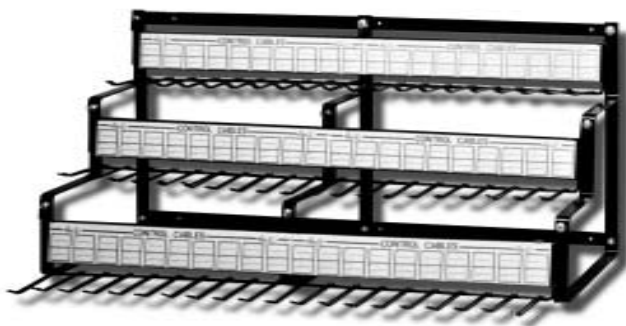

36" Cable Rack Only

121-01151

- 20-slot cable holding system
- White epoxy finish

18" Cable Rack Only

121-01150

- 10-slot cable holding system.
- Black epoxy finish.

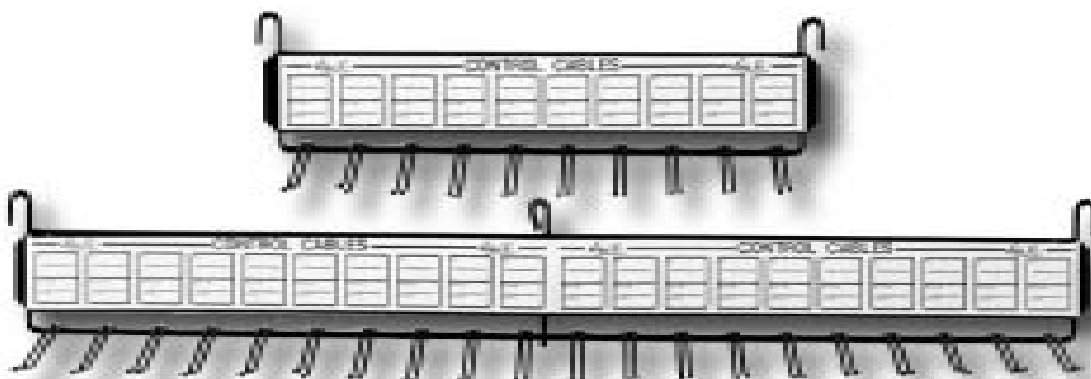

INDEX

PAINT

HANDLEBARS

STREET LEVERS

FORK SEALS

CABLES

SUSPENSION

ELECTRICAL

FILTERS

BRAKE LINES

BRAKES

CABLE MAKING SUPPLIES

CONTROLS

DUAL SPORT

MANUALS

FSO PRODUCTS

EMGO

DRIVE

DISPLAY

JETS

BEARINGS

EYEWEAR

VINTAGE

MIRRORS

EUROPEAN

KICKERS

SHIFTERS

MISC

HARD PARTS

SHOP TOOLS

CHEMICALS

TOOLS

Infra-Red, Electric Mat, Electric Eye

Ray-O-Matic PIR Detector Entrance Alarm and annunciator system

522-05100

High tech passive infra-red detectors have been designed into customer annunciating systems. A curtain of security can now protect any opening. Our small and attractive unit mounts above the door, out of reach and out of mind. The body heat of a person passing through the door will activate the "PIR" detector. People can no longer crawl under or jump over the annunciator system. At last an annunciating system that can truly be thought of as security!

The "IR-51 Ray-O-Matic", is a complete annunciator kit that anyone can install. The system consists of a compact detector unit 2-3/8" wide by 1" deep by 3-3/4" high. It comes with a mounting bracket for locations that may warrant it, a UL approved 12 volt AC transformer, a pleasant-sounding chime, 70 feet of low-voltage wire, simple installation instructions and one-year factory warranty.

The "IR-51 Ray-O-Matic" can be mounted to span a distance of 25 feet even in brilliant sunlight. It is unique because it is a one-piece, low-voltage detector that can be moun over the door. The detector looks for a change of heat in a dual pattern which eliminates false rings from changes in sunlight, car lights, flashes of light, heating systems, etc.

Features:

- *Versatile, undetectable, inexpensive, indispensable
- *Mounts over the door, out of reach
- *No light bulbs to change
- *Invisible detection
- *Cannot be seen from the outside

*Low-voltage meets building and safety codes

*Safe, UL approved 12-volt power supply

*Performs well in both dim and bright sunlight

*Saves installation casts-install it yourself in minutes

*Full one-year limited warranty

*A quality product, made in the U.S.A. by Snyder.

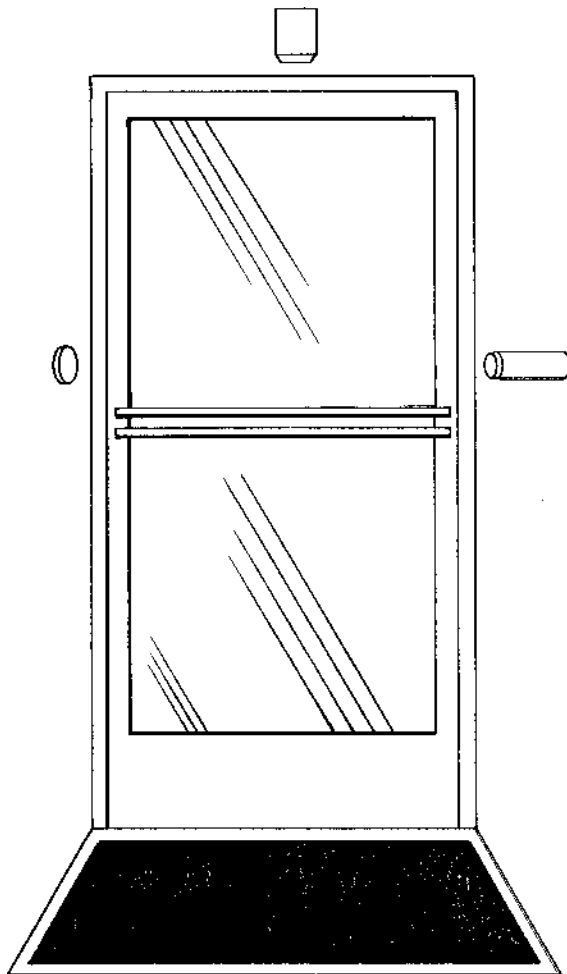

Mat annunciator kit

522-03610

Mat annunciator kit complete for announcing people entering or leaving your premises. When a person steps on the special mat covered by your entry carpet. A chime is sounded making you aware of their entry. Kit contains 30" x 36" x 3/32" special black mat, 50ft. low voltage wire, chime, transformer and instructions

522-03669

Replacement sensor mat only

522-01215

Replacement transformer - all units

Shop Equipment

INDEX

PAINT

HANDLEBARS

STREET LEVERS

FORK SEALS

CABLES

SUSPENSION

ELECTRICAL

FILTERS

BRAKE LINES

BRAKES

CABLE MAKING SUPPLIES

CONTROLS

DUAL SPORT

MANUALS

FSO PRODUCTS

EMGO

DRIVE

DISPLAY

JETS

BEARINGS

EYEWEAR

VINTAGE

MIRRORS

EUROPEAN

KICKERS

SHIFTERS

MISC

HARD PARTS

SHOP TOOLS

CHEMICALS

TOOLS

Parts Bin Boxes

For best price, order 50 of a size

18 Inches Long

109-01802	18 x 2 x 4 1/2
109-01803	18 x 3 x 4 1/2
109-01804	18 x 4 x 4 1/2
109-01806	18 x 6 x 4 1/2
109-01808	18 x 8 x 4 1/2
109-01810	18 x 10 x 4 1/2
109-01812	18 x 12 x 4 1/2

12 Inches Long

109-01202	12 x 2 x 4 1/2
109-01204	12 x 4 x 4 1/2
109-01206	12 x 6 x 4 1/2
109-01210	12 x 10 x 4 1/2



Tiny Bin Boxes

109-22402	Bin box divider fits 2" wide
109-22404	Bin box divider box fits 4" wide
109-22406	Bin Box divider box fits 6" wide

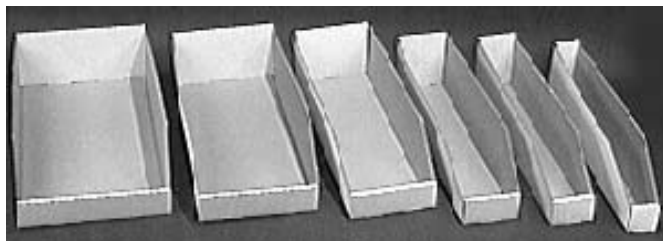
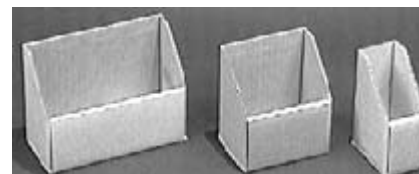

Plastic Parts Boxes

113-00824
24 compartment flexible yellow plastic box.
Overall dimensions:
12" x 8-5/8" x 2-1/4"
Compartment dimensions:
2-1/16" x 2-1/16" x 2-1/16"

Great for nuts and bolts.



2" x 1-11/16" x 1-1/2"

Great for jets and needles

113-00200
18 compartment flexible clear plastic box.
Overall dimensions:
8-3/8" x 4-1/4" x 1- 5/16"
Compartment dimensions:
1-5/16" x 1- 5/16" x 1-3/16".
Great for cable fittings

113-00618
18 compartment flexible yellow plastic box.
Overall dimensions:
10-7/8" x 6-1/2" x 1- 3/4" Compartment dimensions:
2" x 1-11/16" x 1-1/2"

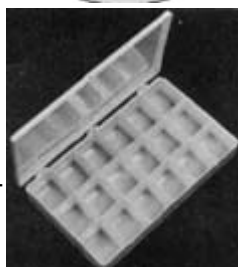

113-00201
12 compartment clear plastic box.
Overall dimensions:
8-3/8" x 4-1/4" x 1- 5/16"
Compartment dimensions:
1-5/16" x 1- 5/16" x 1-3/16"
2" x 1-5/16" x 1-3/16"
4-1/8" x 1-5/16" x 1-3/16"

Great for screws and jets

113-00612
12 compartments flexible yellow plastic box.
Overall dimensions:
10-7/8" x 6-1/2" x 1- 3/4" Compartment dimensions:
2" x 1-11/16" x 1-1/2"



113-00210
9 compartment clear plastic box.
Overall dimensions:
7-1/16" x 3-1/2" x 1- 1/4"
Compartment dimensions:
1-5/8" x 1- 3/8" x 1-1/8"
3-7/16" x 1-1/8" x 1-1/8"

113-00220
6 compartment clear plastic box

Racer Special Spare Parts Box

A real solution to carrying small parts, tools and hardware to a race or work site. Contents are always visible and compartment sizes can be changed with the individual dividers provided. Either box makes a great storage system when purchased in multiples. See through lid shuts tight making spill proof in truck.

113-10320	18-1/2" x 13" x 3"
*32 Compartments	*24 removable dividers
113-72400	15" x 11-3/4" x 2-1/2"
*24 Compartments	*15 removable dividers



Rev. 03-15-06

Shop Equipment

Display Hooks

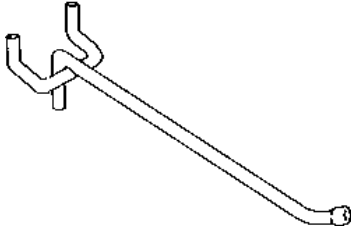

All wire display hooks for use on 1/4" peg board galvanized. .212" diameter wire.

458-21804	4"
458-21806	6"
458-21808	8"
458-21810	10"

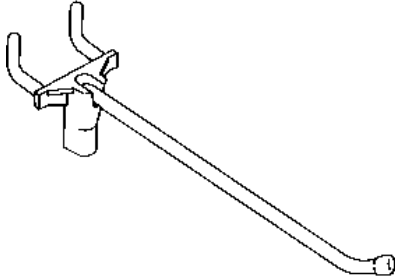

Peg or Slatwall hooks. Plastic base allows non-marring use on 1/4" peg or slat wall displays. Galvanized .212" diameter wire

458-23004	4"
458-23006	6"
458-23008	8"
458-23010	10"

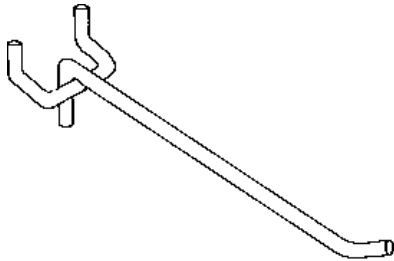

Utility Hooks .312 wire for use on heavy objects. 10" long Galvanized.

458-21420	10"
-----------	-----

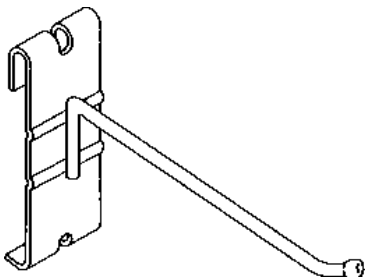

Gridwall Hooks for 3" wire gridwalls with stamped metal base with .212" diameter wire. Galvanized

458-64004	4"
458-64006	6"
458-64008	8"
458-64010	10"

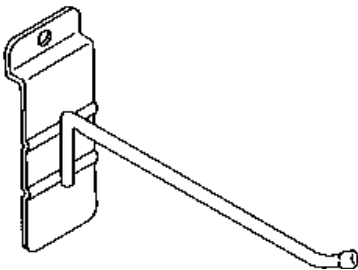

Slatwall Hooks, stamped metal base with .212" wire. Galvanized.

458-24304	4"
458-24306	6"
458-24308	8"
458-24310	10"

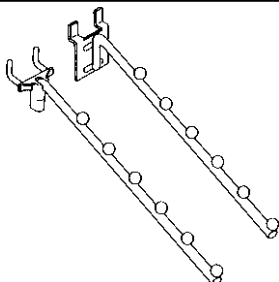

Waterfall Garment Hooks. In standard for T-shirts, Jerseys and Heavy Duty for leather jackets etc. 12" long.

458-24605	STD.
458-24607	HD

INDEX

PAINT

HANDLEBARS

STREET LEVER

FORK SEALS

CABLES

SUSPENSION

ELECTRICAL

FILTERS

BRAKE LINES

BRAKES

CABLE MAKING SUPPL

CONTROLS

DUAL SPORT

MANUALS

FSO PRODUCTS

EMGO

DRIVE

DISPLAY

JETS

BEARINGS

EYEWEAR

VINTAGE

MIRRORS

EUROPEAN

KICKERS

SHIFTERS

MISC

HARD PARTS

SHOP TOOLS

CHEMICALS

TOOLS

Rev. 03-15-06

Shop Equipment

Display Hooks

INDEX

PAINT

HANDLEBARS

Scanner Hooks may be used on peg or slat board.
Enables placement of price and ID labels up front.
Label holders must be ordered seperatley.

STREET LEVERS

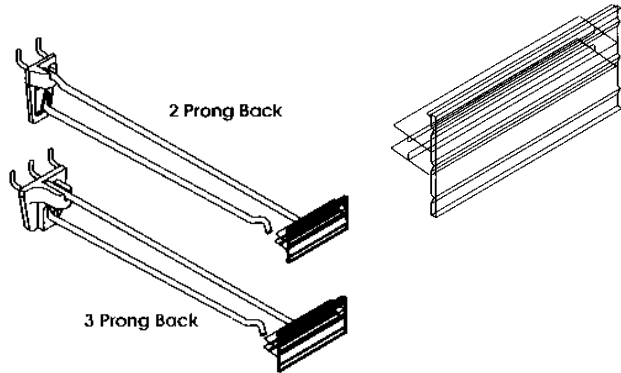

FORK SEALS

458-33004	4"
458-33006	6"
458-33008	8"
458-33009	9"
458-35003	Label Holders
458-01033	Labels - 33 per sheet

CABLES

SUSPENSION

ELECTRICAL

FILTERS

BRAKE LINES

All wire loop hooks for heavier objects.
.186" diameter wire. Galvanized.

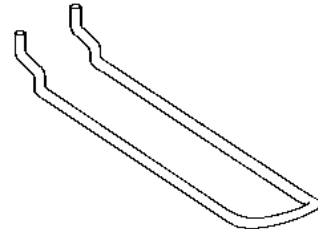

BRAKES

458-32004	4"
458-32006	6"
458-32008	8"

CABLE MAKING SUPPLIES

CONTROLS

DUAL SPORT

MANUALS

Shelf Bracket may be used on peg or slat board,
uses non-marring plastic hooks.

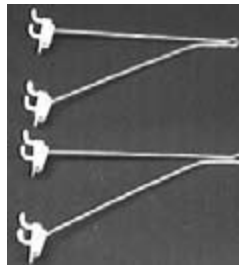

Shelf Brackets

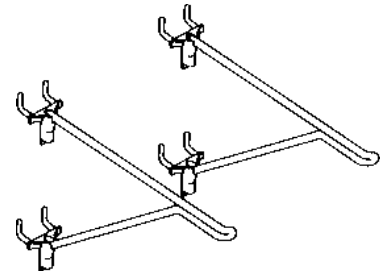

FSO PRODUCTS

458-23108	8"
458-23110	10"
458-23112	12"

EMGO

DRIVE

DISPLAY

JETS

BEARINGS

Peg board mount rack.

EYEWEAR

132-21018



VINTAGE

MIRRORS

EUROPEAN

KICKERS

SHIFTERS

MISC

HARD PARTS

SHOP TOOLS

CHEMICALS

TOOLS

Rev. 03-15-06

Microfiche Reader & Bulb Socket



Microfiche Reader

523-20100

The new Datamate 495A Reader is a very compact unit, providing excellent service for motorcycle applications while being an exceptional value. Equipped with the standard 42x lens its 11 x 14" screen is perfect for Honda, Suzuki, Yamaha, & Harley micro films. Silent operation (No fan).

Screen Size: 11"H x 14"W Fiche Size: 4" x 6"

Overall Size: 15.3"H x 13"W x 15.4"D

Weight: 15 lbs. (UPS 25 lbs.)

Standard Lens: 42 x

Optional Lenses: may be special ordered

Factory Warranty: 36 months except lamp and glass.

Lamp Type: FLT 13.8V 25W

Please use 3 letter code on bulb to determine correct replacement lamp.

Replacement Lamps

523-10401

FLS Fits: Datamate 414 28 watt, 12 volt; **Figure A**

523-10237

FLT Fits: Datamate 495A; Eye-Com 1000, 1100, 1200, 2000, 2100, 3000, 8100; Micron XL Series. . 25
13. 8 volt; **Figure A**

watts,

523-11157

FCS Fits: Bell & Howell SR series, Microdesign Readers supplied by Honda, Yamaha & Suzuki, 150 watt,
24 volt; **Figure C**

523-10205

DED Fits: Datamate 100 & 175; Eye-Com 5000; Bell & Howell ABR IV, ABR VIII, ABR900 85 watt, 13
Figure B

volt.;

523-11160

FDT Fits: NCR 200, 243, 300, 500, 456-3. 100 watts, 12 Volt; **Figure C**

523-10212

DDS Fits: Micron 700 series from Kawasaki; NCR Ultra VII. 80 Watts, 21 Volt; **Figure A**

523-11161

FML Bell & Howell R735 from Yamaha; Figure A

Figure A



Figure B



Figure C



Bulb Socket

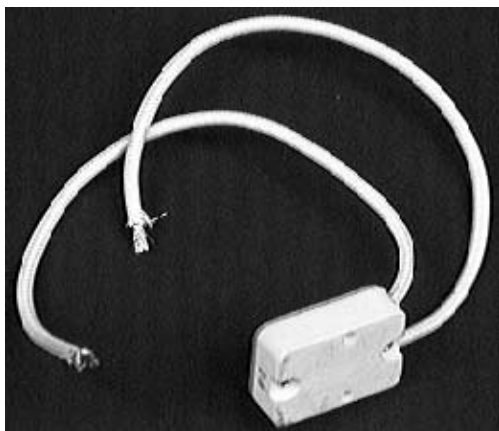

523-20005 Bulb Socket for FLT, DED,
FLS, FDT & DDS

523-20017 Bulb Socket for FCS

INDEX

PAINT

HANDLEBARS

STREET LEVERS

FORK SEALS

CABLES

SUSPENSION

ELECTRICAL

FILTERS

BRAKE LINES

BRAKES

CABLE MAKING SUPPLIES

CONTROLS

DUAL SPORT

MANUALS

FSO PRODUCTS

EMGO

DRIVE

DISPLAY

JETS

BEARINGS

EYEWEAR

VINTAGE

MIRRORS

EUROPEAN

KICKERS

SHIFTERS

MISC

HARD PARTS

SHOP TOOLS

CHEMICALS

TOOLS

High Speed Price Marker



- 521-01400 Price marker with one row of numbers
- 521-01401 Roll 1,000 white 1/2" x 3/4" labels
- 521-01402 Roll 1,000 dayglo red 1/2" x 3/4" labels
- 521-01403 Ink Roller
- 521-01404 Price marker with two rows of numbers
- 521-01405 Roll 600 white 3/4" x 3/4" labels
- 521-01406 Roll 600 dayglo red 3/4" x 3/4" labels

Catalog Holder Accesories

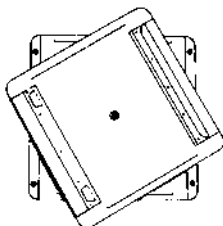

- 291-06612 Black (turntable only)
- 291-06613 Gray (turntable only)

Turnable, pivots 360 degrees. Holds #291-01006, 291-01007, 291-01012, 291-01013, 291-01206 or 291-01207 from opposite page. Allows you to show catalog items to customers with ease.

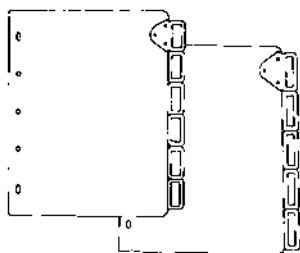

- 291-05175 Index divider kit with 1/5" cut tabs containing 5 pages and inserts.

Shop Equipment

Catalog Holders



291-01006 Black
291-01007 Gray
Steel catalog holder, 30 degree angle, for counter. Holds six section units (not included - must be ordered seperately - see below), includes end wings.

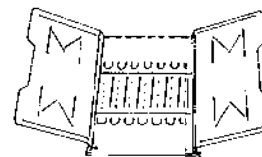

291-01012 Black
291-01013 Gray
Steel catalog holder, 30 degree angle, for counter. Holds twelve section units (not included - must be ordered seperately - see below), includes end wings.

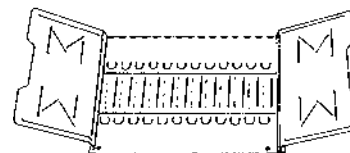

291-01206 Black
291-01207 Gray
Add on section extension. Will contain six section units (not included - must be ordered separately - see below), does not include end wings.

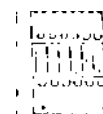

291-01212 Black
291-01213 Gray
Add on section extension. Will contain twelve section units (not included - must be ordered seperately - see below), does not include end wings.

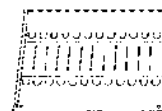

291-05000 Black.
291-05001 Gray
End wings only for catalog holder stand



291-02023
Post section for three hole catalogs and loose sheets, 1 inch capacity



291-02024
Post section for four hole catalogs, (Harley parts books) and loose sheets, 1 inch capacity

291-02043
Double post section for three hole catalogs and loose sheets, 2-3/16 inch capacity

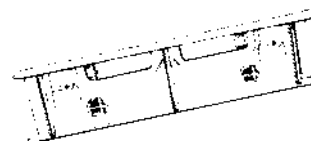

291-02044
Double section for 4 hole catalogs, (Harley parts books) and loose sheets, 2 3/16 inch capacity

291-02013
Ring section for three hole catalogs and loose sheets, 1 inch capacity



291-02033
Double ring section for three hole catalogs and loose sheets, 2 3/16 inch capacity

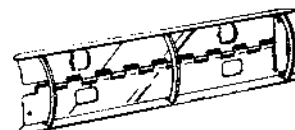

291-02020
Bar section for bound catalogs that are not drilled. Holds catalogs with a rod across the middle pages

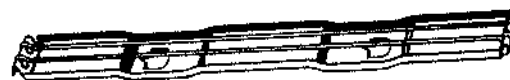

Rev. 03-15-06

- INDEX
- PAINT
- HANDLEBARS
- STREET LEVER
- FORK SEALS
- CABLES
- SUSPENSION
- ELECTRICAL
- FILTERS
- BRAKE LINES
- BRAKES
- CABLE MAKING SUPPL
- CONTROLS
- DUAL SPORT
- MANUALS
- F50 PRODUCTS
- EMGO
- DRIVE
- DISPLAY
- JETS
- BEARINGS
- EYEWEAR
- VINTAGE
- MIRRORS
- EUROPEAN
- KICKERS
- SHIFTERS
- MISC
- HARD PARTS
- SHOP TOOLS
- CHEMICALS
- TOOLS